

CÂBLE EN ACIER GALVANISÉ TYPE AVIATION

Le câble en acier galvanisé "Aircraft" est recommandé pour les applications nécessitant une grande résistance à la fatigue et un minimum d'étirement. Fils antigiratoires conformes aux exigences relatives au matériel militaire des États-Unis. Le câble antigiratoire en acier galvanisé est l'un des câbles de petit diamètre le plus utilisé.



GALVANIZED STEEL AIRCRAFT CABLE

Preformed galvanized aircraft cable is recommended whenever high strength resistance to fatigue and minimum stretch are required. Individual wires are fully preformed. Manufactured to United States military specifications. Galvanized aircraft cable is one of the most widely used small diameter cables

Numéro produit Product number	Diamètre Diameter		Résistance nominale à la rupture Nominal breaking strength		Effort admissible Safe working load		Poids approx. / 1000 PI Approx. weight / 1000 FT		Rouleau 500' Reel	
	po./in.	mm	lb	kg	lb	kg	lb	kg	Diamètre tête Head diameter	Largeur Width
7X7-01	1/16"	1.6	480	218	96	44	7.5	3.4	8-1/2"	6-1/4"
7X7-02	3/32"	2.5	920	417	184	84	16.0	7.3	8-1/2"	6-1/4"
7X7-03	1/8"	3.2	1,700	771	340	154	28.5	12.9	8-1/2"	6-1/4"
7X7-04	5/32"	4.0	2,600	1,180	520	236	43.0	19.5	8-1/2"	6-1/4"
7X7-05	3/16"	5.0	3,700	1,678	740	336	62.0	28.1	8-1/2"	6-1/4"

Numéro produit Product number	Diamètre Diameter		Résistance nominale à la rupture Nominal breaking strength		Effort admissible Safe working load		Poids approx. / 1000 PI Approx. weight / 1000 FT		Rouleau 500' Reel	
	po./in.	mm	lb	kg	lb	kg	lb	kg	Diamètre tête Head diameter	Largeur Width
7X19-03	1/8"	3.2	2,000	907	400	180	29	13.2	8-1/2"	6-1/4"
7X19-04	5/32"	4.0	2,800	1,270	560	254	45	20.4	8-1/2"	6-1/4"
7X19-05	3/16"	5.0	4,200	1,905	840	380	65	29.5	8-1/2"	6-1/4"
7X19-06	1/4"	6.5	7,000	3,175	1,400	635	110	49.9	10-1/2"	7-1/2"
7X19-08	5/16"	8.0	9,800	4,445	1,960	890	173	78.5	15-3/4"	10"
7X19-10	3/8"	9.5	14,400	6,532	2,880	1,310	245	111.1	15-3/4"	10"

CÂBLE EN ACIER GALVANISÉ RECOUVERT DE VINYLE - CPV

Câble d'aviation en acier galvanisé recouvert de vinyle CPV clair de haute qualité.

PVC - VINYL COATED GALVANIZED STEELCABLE

Galvanized steel aircraft cable coated with high quality clear PVC

COMPOSITION 7x7 FLEXIBLE		COMPOSITION 7x19 EXTRA FLEXIBLE	
ROULEAU STANDARD 500 ou 1,000 pieds par rouleau. Surcharge de 15% pour toutes longueurs coupées.		STANDARD REEL 500 or 1,000 feet per reel. 15% surcharge for all cut lengths	

CPV Clair
Clear PVC



Numéro produit Product number	Diamètre câble d'acier Steel cable diameter		Composition	Diamètre extérieur Outside Diameter		Résistance nominale à la rupture Nominal breaking strength		Rouleau 500' Reel	
	po./in.	mm		po./in.	mm	lb	kg	Diamètre tête Head diameter	Largeur Width
PVC7-02	3/32"	2.5	7x7	3/16"	4.8	920	417	8-1/2"	6-1/4"
PVC7-03	1/8"	3.2	7x7	3/16"	4.8	1,700	771	8-1/2"	6-1/4"
PVC19-05	3/16"	4.8	7x19	1/4"	12.7	4,200	1,905	8-1/2"	6-1/4"

CÂBLE EN ACIER INOXYDABLE TYPE AVIATION

Le câble en acier inoxydable "Aircraft" est recommandé pour les applications nécessitant une grande résistance à la fatigue et un minimum d'étirement. Fils antigratoires conformes aux exigences relatives au matériel militaire des États-Unis. Le câble antigratoire en acier inoxydable est l'un des câbles de petit diamètre le plus utilisé.

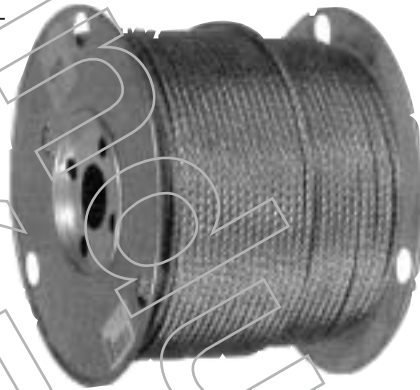

STAINLESS STEEL AIRCRAFT CABLE

Preformed stainless aircraft cable is recommended whenever high strength resistance to fatigue and minimum stretch are required. Individual wires are fully preformed. Manufactured to United States military specifications. Stainless aircraft cable is one of the most widely used small diameter cables

COMPOSITION
7x7
FLEXIBLE



ROULEAU STANDARD

500 ou 1,000 pieds par rouleau.
Surcharge de 15% pour toutes
longueurs coupées.

STANDARD REEL

500 or 1,000 feet per reel.
15% surcharge for all cut
lengths

Numéro produit Product number	Diamètre Diameter		Résistance nominale à la rupture Nominal breaking strength		Effort admissible Safe working load		Poids approx. / 1000 PI Approx. weight / 1000 FT	
	po./in.	mm	lb	kg	lb	kg	lb	kg
7X7SS-01	1/16"	1.6	480	218	96	44	7.5	3.4
7X7SS-03	1/8"	3.2	1,700	771	340	154	28.5	12.9
7X7SS-05	3/16"	5.0	3,700	1,678	740	336	62.0	28.1

COMPOSITION
7x19
ULTRA FLEXIBLE



ROULEAU STANDARD

500 ou 1,000 pieds par rouleau.
Surcharge de 15% pour toutes
longueurs coupées.

STANDARD REEL

500 or 1,000 feet per reel.
15% surcharge for all cut
lengths

Numéro produit Product number	Diamètre Diameter		Résistance nominale à la rupture Nominal breaking strength		Effort admissible Safe working load		Poids approx. / 1000 PI Approx. weight / 1000 FT	
	po./in.	mm	lb	kg	lb	kg	lb	kg
7X19SS-03	1/16"	1.6	480	218	96	44	7.5	3.4
7X19SS-05	1/8"	3.2	1,700	771	340	154	28.5	12.9
7X19SS-06	3/16"	5.0	3,700	1,678	740	336	62.0	28.1

**NE PAS UTILISER POUR ÉLEVER DES OBJETS AU-DESSUS DE LA TÊTE.
NOT TO BE USED FOR OVERHEAD LIFTING**

BAGUE OVALE EN ALUMINIUM

ALUMINIUM OVAL SLEEVE

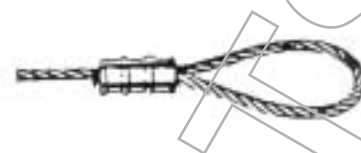
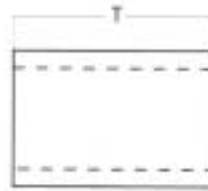
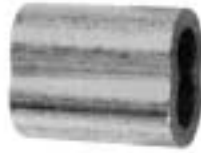

Numéro produit Product number	Emballage Pack	Diamètre du câble Cable diameter	A	H	T	No. Produit en sac poly avec code à barres Product No. poly bag with bar code	Quantité par sac Quantity per bag	Sacs par boîte Bags per box
AOS2	100	1/16"	5/64"	5/32"	3/8"	AOS2-P	5	10
AOS3	100	3/32"	1/8"	1/4"	1/2"	AOS3-P	5	10
AOS4	100	1/8"	5/32"	5/16"	5/8"	AOS4-P	5	10
AOS5	50	5/32"	3/16"	3/8"	11/16"	AOS5-P	5	10
AOS6	50	3/16"	7/32"	7/16"	1"	AOS6-P	5	10
AOS7	20	1/4"	9/32"	9/16"	1-1/8"	AOS7-P	4	10
AOS8	10	5/16"	3/8"	23/32"	1-1/4"	AOS8-P	3	10
AOS9	10	3/8"	7/16"	27/32"	1-7/16"	AOS9-P	1	10

BAGUE D'ARRÊT EN ALUMINIUM

ALUMINIUM STOP SLEEVE

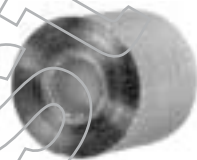

Numéro produit Product number	Emballage Pack	Diamètre du câble Cable diameter	Longueur Length	Diamètre extérieur Outside diameter	No. Produit en sac poly avec code à barres Product No. poly bag with bar code	Quantité par sac Quantity per bag	Sacs par boîte Bags per box
AST2	50	1/16"	3/16"	1/4"	AST2-P	5	10
AST3	50	3/32"	5/16"	11/32"	AST3-P	5	10
AST4	50	1/8"	5/16"	11/32"	AST4-P	5	10
AST5	50	5/32"	5/16"	7/16"	AST5-P	5	10
AST6	50	3/16"	5/16"	7/16"	AST6-P	5	10
AST7	20	1/4"	11/16"	11/16"	AST7-P	4	10



BAGUE OVALE
OVAL SLEEVE

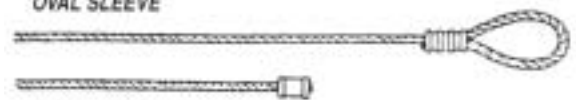

BAGUE D'ARRÊT
STOP SLEEVE

TENDEURS

En acier forgé

TURNBUCKLES

Drop forged steel

OEIL & OEIL, GALVANISÉ À CHAUD

EYE & EYE, HOT GALVANIZED

Numéro produit Product number	Diamètre filetage Thread diameter	Racourcissement Take up	Longueur		Effort admissible Safe working load
			ouvert Lenght opened	fermé Lenght closed	
			po. / in.		lb.
201-064	1/4"	4"	12-1/4"	8-1/4"	500
201-0845	5/16"	4-1/2"	14-1/8"	9-5/8"	800
201-106	3/8"	6"	18-1/8"	12-1/8"	1,200
201-136	1/2"	6"	20"	14"	2,200
201-1312	1/2"	12"	32"	20"	2,200
201-166	5/8"	6"	21-5/8"	15-5/8"	3,500
201-169	5/8"	9"	27-5/8"	18-5/8"	3,500
201-1612	5/8"	12"	33-5/8"	21-5/8"	3,500
201-196	3/4"	6"	23-5/8"	17-5/8"	5,200
201-199	3/4"	9"	29-5/8"	20-5/8"	5,200
201-1912	3/4"	12"	35-5/8"	23-5/8"	5,200
201-1918	3/4"	18"	47-5/8"	29-5/8"	5,200



CROCHET & OEIL, GALVANISÉ À CHAUD

HOOK & EYE, HOT GALVANIZED

Numéro produit Product number	Diamètre filetage Thread diameter	Racourcissement Take up	Longueur		Effort admissible Safe working load
			ouvert Lenght opened	fermé Lenght closed	
			po. / in.		lb.
202-064	1/4"	4"	12-1/8"	8-1/8"	400
202-0845	5/16"	4-1/2"	13-1/2"	9"	700
202-106	3/8"	6"	18"	12"	1,000
202-136	1/2"	6"	19-5/8"	13-5/8"	1,500
202-139	1/2"	9"	25-5/8"	16-5/8"	1,500
202-1312	1/2"	12"	31-5/8"	19-5/8"	1,500
202-166	5/8"	6"	21-1/2"	15-1/2"	2,250
202-169	5/8"	9"	27-1/2"	18-1/2"	2,250
202-1612	5/8"	12"	33-1/2"	21-1/2"	2,250
202-196	3/4"	6"	23-1/2"	17-1/2"	3,000
202-199	3/4"	9"	29-1/2"	20-1/2"	3,000
202-1912	3/4"	12"	35-1/2"	23-1/2"	3,000
202-1918	3/4"	18"	47-1/2"	29-1/2"	3,000

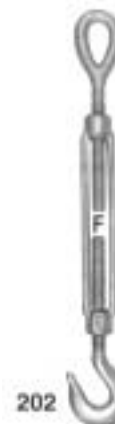

CORPS TENDEUR, NOIR

BODY ONLY, BLACK

Numéro produit Product number	Diamètre filetage Thread diameter	Racourcissement Take up	Longueur totale Total lenght	Effort admissible
				Safe working load
			po. / in.	lb.
204-106	3/8"	6"	7-1/8"	1,200
204-136	1/2"	6"	7-1/2"	2,200
204-166	5/8"	6"	7-7/8"	3,500
204-196	3/4"	6"	8-1/4"	5,200
204-226	7/8"	6"	8-5/8"	7,200
204-256	1"	6"	9"	10,000

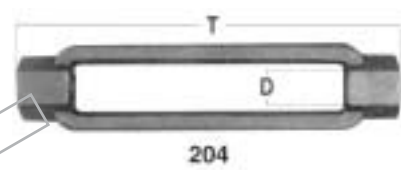

BOUT DROIT, NOIR

STUB END, BLACK

Numéro produit Product number	Diamètre filetage Thread diameter	Racourcissement Take up	Longueur fermée Closed lenght	Effort admissible
				Safe working load
			po. / in.	lb.
204-106	3/8"	6"	16-1/4"	1,200
204-136	1/2"	6"	16-1/4"	2,200
204-166	5/8"	6"	16-1/4"	3,500
204-196	3/4"	6"	17-1/2"	5,200
204-226	7/8"	6"	18-1/2"	7,200
204-256	1"	6"	19-1/2"	10,000



**SERRE-CÂBLE
GALVANISÉ**

Modèle commercial

Numéro produit Product number	No. Produit avec code à barres Product No. with bar code	Grandeur Size	Emballage Pack
500-03	500-03BC	1/8"	25
500-05	500-05BC	3/16"	25
500-06	500-06BC	1/4"	25
500-08	500-08BC	5/16"	10
500-10	500-10BC	3/8"	10
500-11	500-11BC	7/16"	10
500-13	500-13BC	1/2"	10
500-16	500-16BC	5/8"	5
500-19	500-19BC	3/4"	1
500-22	----	7/8"	1
500-25	----	1"	1
500-38	----	1-1/2"	1

**GALVANIZED
MALLEABLE CLIP**

Modèle commercial

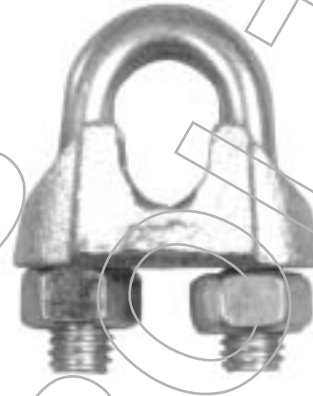

500

**COSSE À CÂBLE
GALVANISÉ**

Modèle commercial

Numéro produit Product number	No. Produit avec code à barres Product No. with bar code	Grandeur Size	Emballage Pack
503-03	503-03BC	1/8"	10
503-05	503-05BC	3/16"	10
503-06	503-06BC	1/4"	10
503-08	503-08BC	5/16"	10
503-10	503-10BC	3/8"	10
503-13	503-13BC	1/2"	10
503-16	503-16BC	5/8"	1
503-19	503-19BC	3/4"	1
503-22	----	7/8"	1
503-25	----	1"	1

**GALVANIZED
THIMBLE**

Modèle commercial



503

CISAILLES À CÂBLE

Fabriquées au Japon. Avec étiquette code à barres

WIRE ROPE CUTTERS

Made in Japan. With bar code sticker

Numéro produit Product number	Capacité Diamètre Diameter capacity	Longueur Length	Poids Weight
	po. / in.		once / ounces
C7	3/16" & Moins / Less	8"	10



Numéro produit Product number	Capacité de coupe Cutting capacity	Longueur Length	Poids Weight
	po. / in.		lb.
RC450	3/8"	18"	4



RC450

EMBOUTISSEURS

Avec étiquette code à barres

SWAGGERS

With bar code sticker

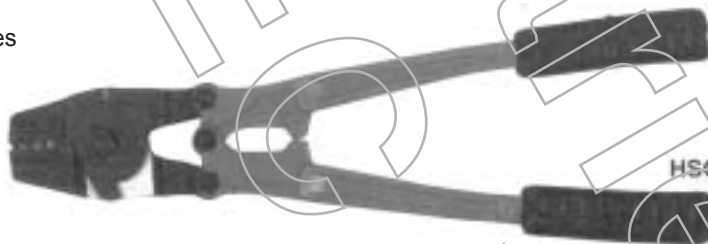

Numéro produit Product number	Pour installer Will stage	Pour For	Longueur Length	Poids Weight
	po. / in.		po. / in.	once / ounces
HSC350 HSC600	1/16", 3/32", 1/8" 1/16", 3/32", 1/8", 5/32", 3/16"	BAGUES OVALES & D'ARRÊT EN ALUMINIUM ALUMINIUM OVAL & STOP SLEEVES	8"	10

**MÂCHOIRES
POUR EMBOUTISSEUR**

**SWAGGER
REPLACEMENT JAWS**

Numéro produit Product number	Pour emboutisseur For swagger	Emballage Pack
BHS14 BHS24	HSC350 HSC600	1 paire / pair 1 paire / pair

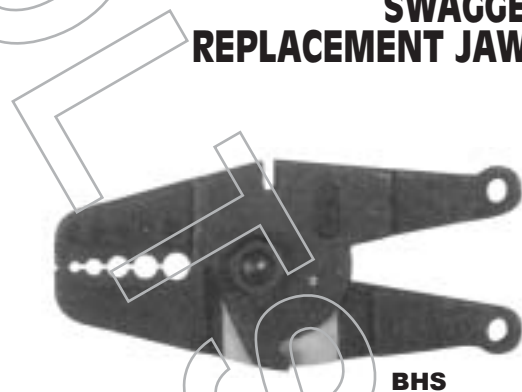

BHS

COUPE-CÂBLE MÉTALLIQUE

Ces coupe-câbles sont conformes à la spécification fédérale des États-Unis GGG-0-800, type III, grandeurs 1-2-3
Valeur fédérale #5110-293-1066.

FABRIQUÉ AUX ÉTATS-UNIS

MADE IN U.S.A.

Numéro produit Product number	Capacité de coupe Cutting capacity	Diamètre base Base diameter	Poids Weight
			po. / in. lb
IM1	3/4"	3-1/2"	7
IM2	1-1/16"	6-3/8"	15
IM3	1-1/2"	8"	27

WIRE ROPE CUTTERS

These cutters conform to United States federal specifications GGG-0-800, type III, sizes 1-2-3
Federal stock #5110-293-1066

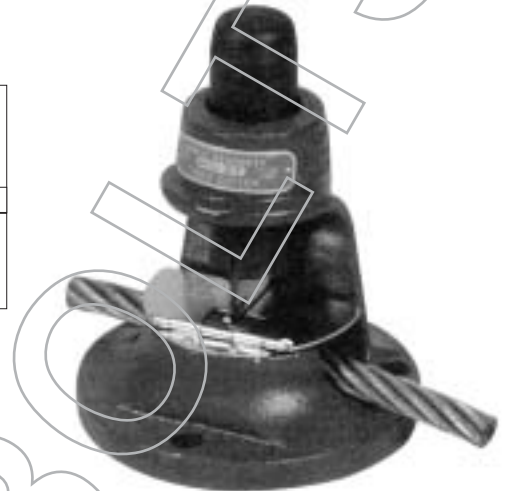

Numéro produit Product number	Pièces Parts
IM1TP IM2TP IM3TP	LAME DU HAUT TOP BLADE
IM1BB IM2BB IM3BB	LAME DU BAS LAME DU HAUT
IM1R IM2R IM3R	BÉLIER RAM
IM1P IM2P IM3P	CHEVILLE POUR LAME PIN OF BLADE
IM1G IM2G IM3G	CHEVILLE POUR GUIDE PIN FOR GUIDE

RAPIDE

La coupe est faite en quelques secondes

SÉCURITAIRE

Les couteaux sont retenus à l'écart au moment de l'impact

ROBUSTE

Résistant au choc, moulage en fer malléable et lames en acier

COUPE PROPRE

Lames taillées en "U" (le haut et le bas), le câble conserve sa forme originale

MOINS COÛTEUX

Que les cisailles hydrauliques ou genre ciseau de capacité égale

RÉPARATION RAPIDES

Exécutées d'un seul coup de marteau

FAST

The cut is made in a matter of seconds

SAFE

All blades retained within the housing at moment of impact

RUGGED

Shock resistant, malleable iron casting and tool steel blades

CLEAN CUTTING "U"

Shaped blades (both top and bottom), help rope keep its original shape

LOWER COST

Than hydraulic or shear type cutters of equal capacity

QUICK FIELD REPAIRS

Made using only a hammer and a punch



MODÈLE #1 MODEL

Coupe Cut size	Diamètre base Base diameter	Poids Weight
	po. / in.	lb
3/4"	3-1/2"	7



MODÈLE #2 MODEL

Coupe Cut size	Diamètre base Base diameter	Poids Weight
	po. / in.	lb
1-1/16"	6-3/8"	15



MODÈLE #3 MODEL

Coupe Cut size	Diamètre base Base diameter	Poids Weight
	po. / in.	lb
1-1/2"	8"	27

CÂBLE NOIR EN ACIER

Torsion à droite, préformé

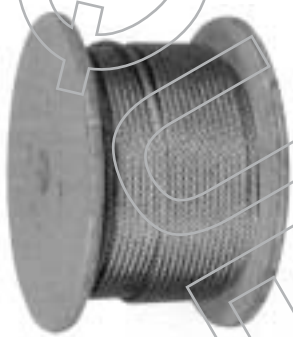

ROULEAU STANDARD 500 ou 1,000 pieds par rouleau. Surcharge de 15% pour toutes longueurs coupées.	STANDARD REEL 500 or 1,000 feet per reel. 15% surcharge for all cut lengths
--	---

BLACK STEEL WIRE ROPE

Right regular lay, preformed

Numéro produit Product number	Diamètre Diameter		Résistance nominale à la rupture Nominal breaking strenght		Poids approx. / 100 PI Approx. weight / 100 FT	
	po./in.	mm	lb	tonnes / tons	lb	kg
6X19FCB08	5/16"	8.0	9,000	4.1	16	7.3
6X19FCB10	3/8"	9.5	13,200	6.0	23	10.5
6X19FCB11	7/16"	11.0	17,600	8.0	31	14.0
6X19FCB13	1/2"	12.5	23,600	10.6	40	18.2
6X19FCB19	3/4"	19.0	50,600	23.0	90	41.0

CÂBLE EN ACIER GALVANISÉ

Torsion à droite, préformé



ROULEAU STANDARD 500 ou 1,000 pieds par rouleau. Surcharge de 15% pour toutes longueurs coupées.	STANDARD REEL 500 or 1,000 feet per reel. 15% surcharge for all cut lengths
--	---

GALVANIZED STEEL WIRE ROPE

Right regular lay, preformed

Numéro produit Product number	Diamètre Diameter		Résistance nominale à la rupture Nominal breaking strenght		Poids approx. / 100 PI Approx. weight / 100 FT	
	po./in.	mm	lb		lb	kg
6X19FCG13	1/2"	12.5	23,600		40	18.2
6X19FCG16	5/8"	16.0	32,000		63	28.6

CÂBLE NOIR EN ACIER

Torsion à droite, préformé
Dimensions et détails techniques sur demande

BLACK STEEL WIRE ROPE

Right regular lay, preformed
Information available on request



ROULEAU STANDARD 500 ou 1,000 pieds par rouleau. Surcharge de 15% pour toutes longueurs coupées.	STANDARD REEL 500 or 1,000 feet per reel. 15% surcharge for all cut lengths
--	---

Numéro produit Product number	Diamètre Diameter		Résistance nominale à la rupture Nominal breaking strenght		Poids approx. / 100 PI Approx. weight / 100 FT	
	po./in.	mm	lb	tonnes / tons	lb	kg
6X19IWRC10	3/8"	9.5	14,080	6.4	25	11.4
6X19IWRC13	1/2"	12.5	24,600	11.2	44	20.0
6X19IWRC16	5/8"	16.0	38,900	17.7	69	31.3
6X19IWRC19	3/4"	19.0	56,000	25.5	99	44.9

CES CÂBLES D'ACIER NE DOIVENT PAS ÊTRE UTILISÉS SOUS AUCUN PRÉTEXTE POUR LE LEVAGE, MAIS SRICTEMENT POUR ATTACHER LA CARGAISON SUR LES BATEAUX.

CES CÂBLES D'ACIER NE DOIVENT PAS ÊTRE UTILISÉS SOUS AUCUN PRÉTEXTE POUR LE LEVAGE, MAIS SRICTEMENT POUR ATTACHER LA CARGAISON SUR LES BATEAUX.

CÂBLE NOIR EN ACIER

Pour attacher la cargaison. Torsion à droite, préformé

BLACK STEEL WIRE ROPE

For deck lashing. Right regular lay, preformed

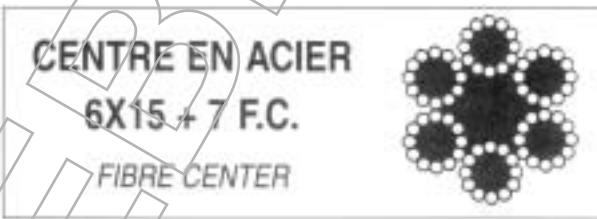
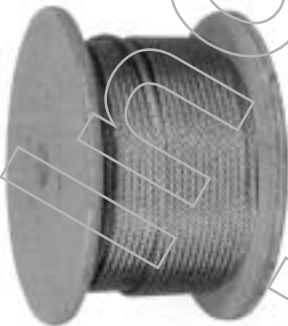

ROULEAU STANDARD 500 ou 1,000 pieds par rouleau. Surcharge de 15% pour toutes longueurs coupées.	STANDARD REEL 500 or 1,000 feet per reel. 15% surcharge for all cut lengths
--	---

Numéro produit Product number	Diamètre Diameter		Résistance nominale à la rupture Nominal breaking strenght		Poids approx. / 100 PI Approx. weight / 100 FT	
	po./in.	mm	lb	tonnes / tons	lb	kg
6X15FC19	3/4"	19	23.600	10.6	59	26.8

CÂBLE DE POLYPROPYLENE JAUNE

Câble jaune 100% polypropylène à trois (3) torons, torsion à droite, sur bobine de carton.

YELLOW POLYPROPYLENE ROPE

Made from 100% polypropylene in three (3) strands, right lay construction, on carton reel.



Numéro produit Product number	Diamètre câble Cable diameter	Longueur câble / bobine Cable length / reel	Résistance nominale à la rupture Nominal breaking strength	Bobine / Reel	
				Diamètre tête Head diameter	Largeur Width
	po. / in.	pi. / ft.	lb	po. / in.	
P05	3/16"	2,125'	720	11"	10-3/4"
P06	1/4"	1,300'	1,120	11"	10-3/4"
P08	5/16"	975'	1,490	11"	10-3/4"
P10	3/8"	630'	2,120	11"	10-3/4"
P13	1/2"	335'	3,650	11"	10-3/4"
P16	5/8"	200'	5,450	11"	10-3/4"
P19	3/4"	125'	7,830	11"	10-3/4"

Chaînes et accessoires / Chains and accessories

CHAÎNE À MAILLONS ORDINAIRES QUALITÉ 30

Soudage électrique. En demi-baril.

PROOF COIL CHAIN GRADE 30

Electric welded, in half-barrel.

FINI NATUREL / SELF COLORED **30SC** DIAMÈTRE PRÉCIS / EXACT SIZE

Numéro produit Product number	Diamètre Diameter		Effort admissible Safe working load	Poids approx. / 100 pi. Approx. weight / 100 ft.		Quantité / Demi-baril Quantité / Half-barrel	
	po. / in.	mm		lb.	pi. / ft.	m	
30SC03	1/8"	3.4	300	13	1,000'	305	
30SC05	3/16"	4.8	630	29	800'	244	
30SC06	1/4"	6.3	1,100	52	450'	137	
30SC08	5/16"	8.0	1,700	86	300'	92	
30SC10	3/8"	9.5	2,400	125	200'	61	
30SC13	1/2"	12.5	4,200	224	100'	30	

GALVANISÉ À CHAUD / HOT DIP GALVANIZED **30HDG** DIAMÈTRE PRÉCIS / EXACT SIZE

Numéro produit Product number	Diamètre Diameter		Effort admissible Safe working load	Poids approx. / 100 pi. Approx. weight / 100 ft.		Quantité / Demi-baril Quantité / Half-barrel	
	po. / in.	mm		lb.	pi. / ft.	m	
30HDG03	1/8"	3.4	300	13	1,000'	305	
30HDG05	3/16"	4.8	630	29	800'	244	
30HDG06	1/4"	6.3	1,100	52	450'	137	
30HDG08	5/16"	8.0	1,700	86	300'	92	
30HDG10	3/8"	9.5	2,400	125	200'	61	
30HDG13	1/2"	12.5	4,200	224	100'	30	

FINI ZINC BRILLANT / BRIGHT **30ZP** DIAMÈTRE PRÉCIS / EXACT SIZE

Numéro produit Product number	Diamètre Diameter		Effort admissible Safe working load	Poids approx. / 100 pi. Approx. weight / 100 ft.		Quantité / Demi-baril Quantité / Half-barrel	
	po. / in.	mm		lb.	pi. / ft.	m	
30ZP03	1/8"	3.4	300	13	1,000'	305	
30ZP05	3/16"	4.8	630	29	800'	244	
30ZP06	1/4"	6.3	1,100	52	450'	137	
30ZP08	5/16"	8.0	1,700	86	300'	92	
30ZP10	3/8"	9.5	2,400	125	200'	61	

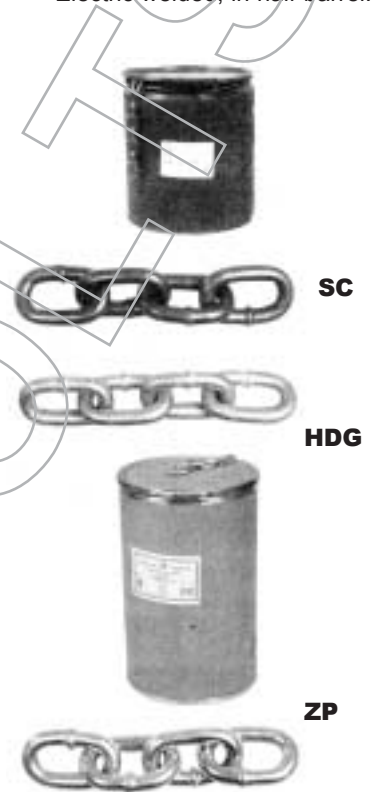

NE PAS UTILISER POUR ÉLEVER DES OBJETS AU-DESSUS DE LA TÊTE. / NOT TO BE USED FOR OVERHEAD LIFTING.

Surcharge de 15% pour toutes longueurs coupées.

15% surcharge for all cut lengths.

COUPE-CHAÎNES

CHAIN CUTTERS



POUR CHAÎNE RÉGULIÈRE

FOR REGULAR CHAIN

Numéro produit Product number	Capacité de coupe Cut capacity	Largeur Width	Profondeur Depth	Hauteur Height	Long. manche Handle length	Poids Weight
25	1/4" GR.30	2"	5"	5"	15"	5

POUR CHAÎNE QUALITÉ 40

FOR GRADE 40 CHAIN

65	3/8" GR.40	4"	7"	7"	20"	17
-----------	------------	----	----	----	-----	----



SUPPORT PRÉSENTOIR

Pour chaîne en seau

Support robuste en acier plaqué zinc. Superposable pour occuper moins d'espace de plancher. Voir notre représentant au sujet du contenu et du prix de ce présentoir.

DISPLAY STAND

For chain in pail

Heavy zinc plated steel display stand. Stackable to save floor space. Ask our representative for content and price of this display.

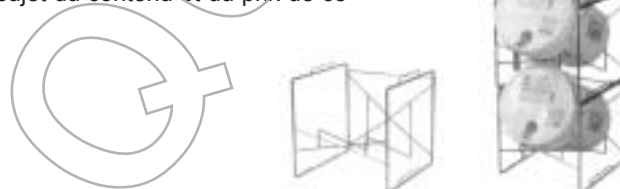

Chaînes et accessoires / Chains and accessories

CHAÎNE À MAILLONS ORDINAIRES QUALITÉ 30

Soudage électrique. Chaîne en seau.

FINI ZINC BRILLANT / BRIGHT ZINC FINISH

P30ZP

DIAMÈTRE PRÉCIS / EXACT SIZE

Numéro produit Product number	Diamètre Diameter		Effort admissible Safe working load	Poids approx. / 100 pi. Approx. weight / 100 ft	Quantité / Seau Quantité / Pail	
	po. / in.	mm			pi. / ft.	m
P30ZP03	1/8"	3.4	300	13	500'	152
P30ZP04	5/32"	4.0	375	21	295'	90
P30ZP05	3/16"	4.8	630	29	265'	81
P30ZP06	1/4"	6.3	1,100	52	150'	46
P30ZP08	5/16"	8.0	1,700	86	100'	30
P30ZP10	3/8"	9.5	2,400	125	65'	20

PROOF COIL CHAIN GRADE 30

Electric welded, chain in pail.



GALVANISÉ À CHAUD / HOT DI P GALVANIZED P30HDG

DIAMÈTRE PRÉCIS / EXACT SIZE

Numéro produit Product number	Diamètre Diameter		Effort admissible Safe working load	Poids approx. / 100 pi. Approx. weight / 100 ft	Quantité / Seau Quantité / Pail	
	po. / in.	mm			pi. / ft.	m
P30HDG03	1/8"	3.4	300	13	500'	152
P30HDG05	3/16"	4.8	630	29	265'	81
P30HDG06	1/4"	6.3	1,100	52	150'	46
P30HDG08	5/16"	8.0	1,700	86	100'	30
P30HDG10	3/8"	9.5	2,400	125	65'	20

NE PAS UTILISER POUR ÉLEVER DES OBJETS AU-DESSUS DE LA TÊTE. / NOT TO BE USED FOR OVERHEAD LIFTING.

CHAÎNE À MAILLONS ORDINAIRES QUALITÉ 30

Soudage électrique. Chaîne en rouleau.

FINI ZINC BRILLANT / BRIGHT ZINC FINISH

R30ZP

DIAMÈTRE PRÉCIS / EXACT SIZE

Numéro produit Product number	Diamètre Diameter		Effort admissible Safe working load	Poids approx. / rouleau Approx. weight / reel	Quantité / rouleau Quantity / reel		Rouleau / Reel Diam. tête / Largeur Head diam. / Width	
	po. / in.	mm			pi. / ft.	m	po. / in.	po. / in.
R30ZP03	1/8"	3.4	300	26	198'	60	8-1/2"	6-1/4"
R30ZP04	5/32"	4.0	375	21	98'	30	8-1/2"	6-1/4"
R30ZP05	3/16"	4.8	630	30	98'	30	8-1/2"	6-1/4"
R30ZP06	1/4"	6.3	1,100	52	98'	30	8-1/2"	12-1/4"
R30ZP08	5/16"	8.0	1,700	64	75'	23	8-1/2"	12-1/4"
R30ZP10	3/8"	9.5	2,400	65	49'	15	8-1/2"	12-1/4"

PROOF COIL CHAIN GRADE 30

Electric welded, chain in reel.

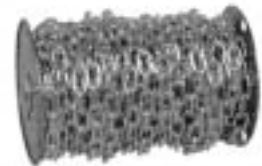

GALVANISÉ À CHAUD / HOT DI P GALVANIZED R30HDG

R30HDG

DIAMÈTRE PRÉCIS / EXACT SIZE

Numéro produit Product number	Diamètre Diameter		Effort admissible Safe working load	Poids approx. / rouleau Approx. weight / reel	Quantité / rouleau Quantity / reel		Rouleau / Reel Diam. tête / Largeur Head diam. / Width	
	po. / in.	mm			pi. / ft.	m	po. / in.	po. / in.
R30HDG03	1/8"	3.4	300	26	198'	60	8-1/2"	6-1/4"
R30HDG05	3/16"	4.8	630	30	98'	30	8-1/2"	6-1/4"
R30HDG06	1/4"	6.3	1,100	52	98'	30	8-1/2"	12-1/4"
R30HDG08	5/16"	8.0	1,700	64	75'	23	8-1/2"	12-1/4"
R30HDG10	3/8"	9.5	2,400	65	49'	15	8-1/2"	12-1/4"

NE PAS UTILISER POUR ÉLEVER DES OBJETS AU-DESSUS DE LA TÊTE. / NOT TO BE USED FOR OVERHEAD LIFTING.

CHAÎNE EN ACIER INOXYDABLE A MAILLONS REGULIERS, QUALITE 316

Vendue au pied à la longueur désirée, sans surcharge

Sold by the foot to exact length required, without surcharge

Numéro produit Product number	Diamètre Diameter		Effort admissible Safe working load	Poids approx. / 100 pi. Approx. weight / 100 ft.
	po. / in.	mm		lb.
30SS04	5/32"	4.0	375	21
30SS05	3/16"	4.8	630	29
30SS06	1/4"	6.3	1,100	52
30SS08	5/16"	8.0	1,700	86
30SS10	3/8"	9.5	2,400	125

STAINLESS STEEL CHAIN WITH REGULAR LINKS GRADE 316



NE PAS UTILISER POUR ÉLEVER DES OBJETS AU-DESSUS DE LA TÊTE. / NOT TO BE USED FOR OVERHEAD LIFTING.

CHAÎNE EN ACIER INOXYDABLE A MAILLONS REGULIERS, QUALITE 316

Vendue en boîte

STAINLESS STEEL CHAIN WITH REGULAR LINKS GRADE 316

Sold in box

Numéro produit Product number	Diamètre Diameter		Effort admissible Safe working load	Poids approx. / 100 pi. Approx. weight / 100 ft.	Quantité / boîte Quantity / box
	po. / in.	mm		lb.	pi. / ft.
B30SS04	5/32"	4.0	375	21	75'
B30SS05	3/16"	4.8	630	29	75'
B30SS06	1/4"	6.3	1,100	52	49'
B30SS08	5/16"	8.0	1,700	86	33'
B30SS10	3/8"	9.5	2,400	125	33'



NE PAS UTILISER POUR ÉLEVER DES OBJETS AU-DESSUS DE LA TÊTE. / NOT TO BE USED FOR OVERHEAD LIFTING.

PRÉSENTOIR DE CHAÎNE ET DE CÂBLE EN ACIER

Support en acier émaillé

PR100

MERCHANDISER DISPLAY FOR CHAIN, POLY & WIRE ROPE

Enameled steel stand

DIMENSIONS : 40 pouces de largeur x 14 pouces de profondeur x 59 pouces de hauteur. Voir notre représentant au sujet du contenu et du prix de ce présentoir.

DIMENSIONS : 40 inches of width x 14 inches of depth x 59 inches of height. Ask our representative for content and price of this display.

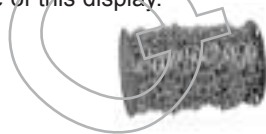

ASSORTIMENT RECOMMANDÉ :

- A** 4 rouleaux de chaîne de 3-1/4" + 4 rouleaux de chaîne de 3-1/2" + 1 rouleau de chaîne de 6-1/4" + 2 rouleaux de chaîne de 7"
- B** 2 rouleaux de chaîne de 4" + 2 rouleaux de chaîne de 4-1/4" + 2 rouleaux de chaîne de 5" + 3 rouleaux de chaîne de 6-1/4"
- C** 6 rouleaux de chaîne de 6-1/4" + 1 rouleau de chaîne de 7-1/4"
- D** 3 rouleaux de chaîne de 6-1/4" + 2 rouleaux de chaîne de 12"
- E** 7 rouleaux de câble d'acier galvanisé de 6-1/4"

SUGGESTED ASSORTMENT :

- A** 4 reels of chain of 3-1/4" + 4 reels of chain of 3-1/2" + 1 reel of chain of 6-1/4" + 2 reels of chain of 7"
- B** 2 reels of chain of 4" + 2 reels of chain of 4-1/4" + 2 reels of chain of 5" + 3 reels of chain of 6-1/4"
- C** 6 reels of chain of 6-1/4" + 1 reel of chain of 7-1/4"
- D** 3 reels of chain of 6-1/4" + 2 reels of chain of 12"
- E** 7 reels of galvanized steel cable of 6-1/4"

Chaînes et accessoires / Chains and accessories

CHAÎNE DE TRANSPORT

G70

TRANSPORT CHAIN

Résistance élevée, qualité 70

La chaîne G70 est une chaîne légère à résistance élevée conçue pour le camionnage, le transport ferroviaire et la construction. Elle s'utilise aussi pour attacher les charges, le remorquage ou toute autre application nécessitant un rapport résistance-poids élevé.

Fin : Or satiné, maillons estampés "70"

Composition : Acier à haute teneur en carbone Ajout de bore pour augmenter la trempabilité et la résistance à la rupture

Accessoires : Crochets fermés ou ouverts qualité 70, dont la charge de rupture est égale à celle de la chaîne G70

Certificat d'essai : Toutes les chaînes G70 sont éprouvées. Certificat d'essai fourni sur demande

High strength, grade 70
The 70G (Grade 70) is a light weight, high strength chain designed for trucking, railroad, logging and construction industries. It is also used for tying down loads, towing or any application where a high strength-to-weight ratio is required.

Finish : Sating gold, links marked "70"

Composition : High carbon steel. Added boron to improve hardenability and resistance to breaking

Attachments : Grade 70 clevis grab or slip hooks are available with same breaking load as 70G chain

Test certificate : All 70G chains are proof tested. Certificate provided on request



CHAÎNE EN DEMI-BARIL

CHAIN IN HALF-DRUM

Numéro produit Product number	Dimension commerce Trade size	Diamètre Diameter		Dim.internes / Inside dim.		Effort admissible Safe working load	Poids / 100 pi. Weight / 100 ft.	Pieds / demi-baril Feet / half-barrel	
				Longueur Length	Largeur Width				
725-06	1/4"	0.275"	7	0.275"	7	3,150	74	400'	1/4"
725-08	5/16"	0.315"	8	0.315"	8	4,700	92	275'	5/16"
725-10	3/8"	0.393"	10	0.393"	10	6,600	148	200'	3/8"
725-13	1/2"	0.512"	13	0.512"	13	11,300	256	100'	1/2"



725

CHAÎNE EN SEAU

CHAIN IN PAIL

Numéro produit Product number	Dimension commerce Trade size	Diamètre Diameter		Dim.internes / Inside dim.		Effort admissible Safe working load	Poids / 100 pi. Weight / 100 ft.	Pieds / seau Feet / pail	
				Longueur Length	Largeur Width				
P725-06	1/4"	0.275"	7	0.82"	0.394"	3,150	74	133'	1/4"
P725-08	5/16"	0.315"	8	1.01"	0.496"	4,700	92	92'	5/16"
P725-10	3/8"	0.393"	10	1.18"	0.575"	6,600	148	66'	3/8"



P725

NE PAS UTILISER POUR ÉLEVER DES OBJETS AU-DESSUS DE LA TÊTE. / NOT TO BE USED FOR OVERHEAD LIFTING.

Surcharge de 15% pour toutes longueurs coupées.

15% surcharge for all cut lengths.

CROCHET À CHAPE

G70

CLEVIS HOOKS

Acier trempé pour utilisation avec chaîne G70. Acier à haute résistance élevée. Avec étiquette code à barres.

Heat treated steel to use with 70G. Extra high tensile steel with bar code sticker.

Alliage d'acier trempé à haute résistance, pour utilisation avec la chaîne G70. Émaillé de couleur orange. Linguet de sécurité en acier inoxydable. Avec étiquette code à barres.

Heat treated allow steel, extra high tensile strength, to be used with 70G transport chain. Painted orange colour. Stainless steel safety latch. With bar code sticker.

CROCHET FERMÉ / GRAB HOOK



677

CROCHET OUVERT / SLIP HOOK



688



688WL

Numéro produit Product number	Grosueur chaîne Chain size	Effort admissible Safe working load	Emb. Pack
677-06	1/4"	3,150	1
677-08	5/16"	4,700	1
677-10	3/8"	6,600	1
677-13	1/2"	12,750	1

Numéro produit Product number	Grosueur chaîne Chain size	Effort admissible Safe working load	Emb. Pack
688-06	1/4"	2,750	1
688-08	5/16"	4,300	1
688-10	3/8"	5,250	1
688-13	1/2"	9,000	1

Numéro produit Product number	Grosueur chaîne Chain size	Effort admissible Safe working load	Emb. Pack
688WL-06	1/4"	2,750	1
688WL-08	5/16"	4,300	1
688WL-10	3/8"	5,250	1

Chaînes et accessoires / Chains and accessories

Chaînes sur rouleau

CHAÎNE À MAILLONS TORSADÉS

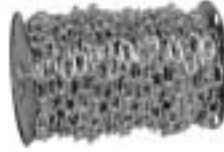

Chains on reel.

TWIST LINK MACHINE CHAIN

EN ACIER PLAQUÉ NICKEL

NICKEL PLATED STEEL

Numéro produit Product number	Dimension commerce Trade Size	Diamètre Diameter		Mailles / pi. Links / ft.	Effort admissible Safe working load	pi. / rouleau ft. / reel	poids. / rouleau weight. / reel	Rouleau / Réel	
		po. / in.	mm					Diam. tête Head diam.	Largeur Width
R505	7	5/64"	2.0	33.00	110	98'	6	7-3/4"	4"
R510	6	3/32"	2.4	26.00	132	98'	9	7-3/4"	4"

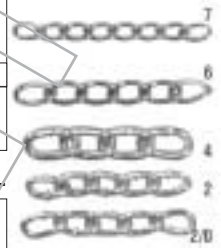

EN ACIER PLAQUÉ ZINC BRILLANT

BRIGHT ZINC PLATED STEEL

R512	4	1/8"	3.5	20.50	200	98'	17	7-3/4"	4-1/4"
R518	2	5/32"	4.0	19.00	287	98'	22	7-3/4"	7-1/4"
R532	2/0	3/16"	5.0	15.25	520	75'	26	8-1/2"	6-3/4"

CHAÎNE À MAILLONS PASSANTS

PASSING LINK CHAIN

EN ACIER PLAQUÉ ZINC BRILLANT

BRIGHT ZINC PLATED STEEL

R542	2/0	3/16"	5.0	13.00	400	147'	50	8-1/2"	12"
------	-----	-------	-----	-------	-----	------	----	--------	-----



CHAÎNE À MAILLONS BLOQUÉS

"TENSO"

COIL CHAIN

EN ACIER PLAQUÉ ZINC BRILLANT

BRIGHT ZINC PLATED STEEL

R550	4	.079"	10.70	70	197'	12	8-1/2"	6"
R560	3	.080"	7.00	90	197'	13	8-1/2"	6"
R575	1	.103"	6.70	155	98'	11	8-1/2"	6"
R579	2/0	.135"	5.30	255	180'	29	8-1/2"	12"



CHAÎNE SOUDÉE À CHASSIS

ENWELDED SASH CHAIN

EN ACIER PLAQUÉ ZINC BRILLANT

BRIGHT ZINC PLATED STEEL

R514	14	0.083"	23.00	75	246'	12	7-3/4"	4-1/4"
------	----	--------	-------	----	------	----	--------	--------



CHAÎNE DE SUSPENSION SIMPLE

SINGLE JACK CHAIN

EN ACIER PLAQUÉ ZINC BRILLANT

BRIGHT ZINC PLATED STEEL

R566	16	0.0640"	24.00	11	295'	10	8"	3-3/4"
R564	14	0.0800"	18.00	16	197'	11	8"	3-3/4"
R562	12	0.1055"	16.00	29	197'	19	8"	5-3/4"

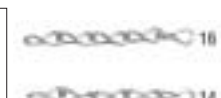

EN ACIER PLAQUÉ LAITON

BRASS PLATED STEEL

R576	16	0.0640"	24.00	11	295'	10	8"	3-3/4"
R574	14	0.0800"	18.00	16	197'	11	8"	3-3/4"
R572	12	0.1055"	16.00	29	197'	19	8"	5-3/4"



CHAÎNE À CHASSIS

SASH CHAIN

EN ACIER PLAQUÉ ZINC BRILLANT

BRIGHT ZINC PLATED STEEL

Numéro produit Product number	Dimension commerce Trade Size	Approx. Mailles / pi. Links / ft.	Effort admissible Safe working load	pi. / rouleau ft. / reel	poids. / rouleau weight. / reel	Rouleau / Réel	
						Diam. tête Head diam.	Largeur Width
R528	8	22.00	75	197'	9	8-1/2"	3-1/2"
R522	80 ou 35	21.00	106	98'	6	8-1/2"	3-1/2"

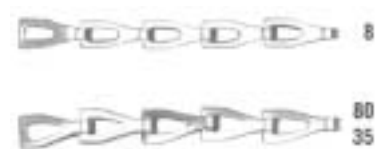

NE PAS UTILISER POUR ÉLÉVER DES OBJETS AU-DESSUS DE LA TÊTE. / NOT TO BE USED FOR OVERHEAD LIFTING.

Chaînes et accessoires / Chains and accessories

Chaînes sur rouleau

CHAÎNE À FOURNAISE

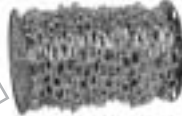

Chains on reel. FURNACE CHAIN

EN ACIER PLAQUÉ ZINC BRILLANT

BRIGHT ZINC PLATED STEEL

Numéro produit Product number	Numéro commercial Trade number	Approx. Mailles / pi. Links / ft.	Effort admissible Safe working load	pi. / rouleau ft. / reel	poids. / rouleau weight. / reel	Rouleau / Reel	
						Diam. tête Head diam.	Largeur Width
R591	91	28,00	41	250'	7	8-1/2"	3-1/2"



91

CHAÎNE SÉCURITAIRE EN LAITON

BRASS SAFETY CHAIN

R520	1/0	24.00	35	200'	5	8-1/2"	3-1/2"
------	-----	-------	----	------	---	--------	--------



1/0

CHAÎNE SÉCURITAIRE EN LAITON

Chaîne à maillons ovales standards,
sur rouleau. Crochets non-inclus.

BRASS SAFETY CHAIN

Standard oval link, on reel.
Hooks not included

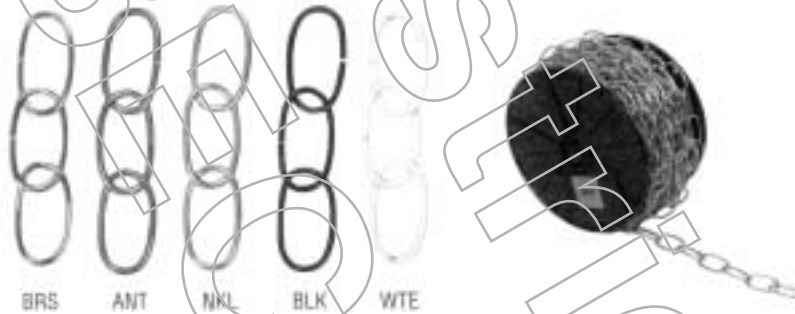

BRS ANT NKL BLK WTE

Numéro produit Product number	Fini Finish	Longueur chaîne / rouleau Chain length / reel		Rouleau / Reel	
		pi. / ft.	m	Diam. tête Head diam.	Largeur Width
R570BRS	PLAQUÉE LAITON / BRASS PLATED	96'	29	8-1/2"	6"
R570ANT	PLAQUÉE LAITON ANTIQUE / ANTIQUE BRASS PLATED	96'	29	8-1/2"	6"
R570NKL	PLAQUÉE NICKEL / NICKEL PLATED	96'	29	8-1/2"	6"
R570BLK	FINI NOIR / BLACK FINISH	96'	29	8-1/2"	6"
R570WTE	FINI BLANC / WHITE FINISH	96'	29	8-1/2"	6"

CORCHET DE PLAFOND

Crochet avec écrou papillon.
Deux crochets par sac poly avec étiquette code à barres.

CEILING HOOK

Hook with toggle bolt.
Two hooks per poly bag with bar code sticker

Numéro produit Product number	Fini Finish	Qté / sac Qty / bag
5788BRS	PLAQUÉE LAITON / BRASS PLATED	2
5788ANT	PLAQUÉE LAITON ANTIQUE / ANTIQUE BRASS PLATED	2
5788NKL	PLAQUÉE NICKEL / NICKEL PLATED	2
5788BLK	FINI NOIR / BLACK FINISH	2
5788WTE	FINI BLANC / WHITE FINISH	2



5788

BRS ANT NKL BLK WTE

Chaînes et accessoires / Chains and accessories

CHAÎNE À BILLES

Chaîne en acier plaquée laiton ou nickel.
Aussi disponible sur de plus gros rouleaux.
Prix sur demande.

BEADED CHAIN

Steel chain, brass or nickel plated.
Also available on larger size reels.
Price on request.

Numéro produit Product number	Fini Finish	Diamètre approx. Approx. diameter	Billes. / pi. Beads / ft.	Longueur chaîne / rouleau Chain length / reel	Rouleau / Reel	
					Diam. tête Head diam.	Largeur Width
		po. / in.	pi. / ft.	po. / in.		
BCB3	LAITON / BRASS	3/32"	100	500'	500'	500'
BCN3	NICKEL	3/32"	100	500'	500'	500'
BCB6	LAITON / BRASS	1/8"	72	250'	250'	250'
BCN6	NICKEL	1/8"	72	250'	250'	250'
BCB10	LAITON / BRASS	3/16"	50	250'	250'	250'
BCN10	NICKEL	3/16"	50	250'	250'	250'

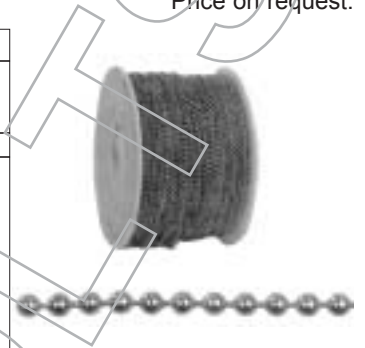

ANNEAU CONNECTEUR

END RING CONNECTOR

Numéro produit Product number	Fini Finish	D		Longueur Length	Pour chaîne For chain	Emballage Pack
		Diam. trou Hole diam.	po. / in.			
		BCB6A	LAITON / BRASS	0.130"	13/32"	3 - 6
BCN6A	NICKEL	0.130"	13/32"	3 - 6	100	
BCB10A	LAITON / BRASS	0.193"	9/16"	10	100	
BCN10A	NICKEL	0.193"	9/16"	10	100	

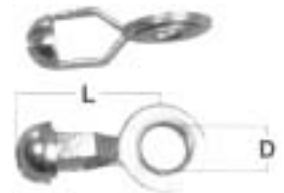

ACCOUPEMENT

COUPLING

Numéro produit Product number	Fini Finish	D		Longueur Length	Pour chaîne For chain	Emballage Pack
		Diam. trou Hole diam.	po. / in.			
		BCB3B	LAITON / BRASS	1/8"	11/32"	3
BCN3B	NICKEL	1/8"	11/32"	3	100	
BCB6B	LAITON / BRASS	3/16"	1/2"	6	100	
BCN6B	NICKEL	3/16"	1/2"	6	100	
BCB10B	LAITON / BRASS	1/4"	5/8"	10	100	
BCN10B	NICKEL	1/4"	5/8"	10	100	

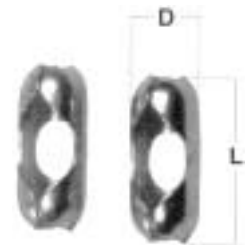

ACCOUPEMENT

COUPLING

Numéro produit Product number	Fini Finish	D		Longueur Length	Pour chaîne For chain	Emballage Pack
		Diam. trou Hole diam.	po. / in.			
		BCB6P	LAITON / BRASS	5/16"	3/8"	3 - 6 - 10
BCN6P	NICKEL	5/16"	3/8"	3 - 6 - 10	100	

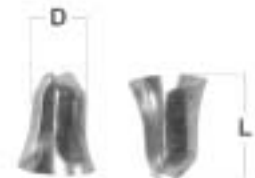

Chaînes et accessoires / Chains and accessories

CHAÎNE DÉCORATIVE EN PLASTIQUE

Légère et sans entretien. Plusieurs usages à l'intérieur comme à l'extérieur.

PLASTIC DECORATIVE CHAIN

Lightweight and maintenance free. Many indoor and outdoor uses.

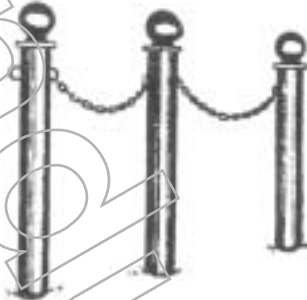
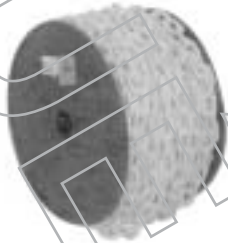

Numéro produit Product number	Couleur Color	Diamètre chaîne Chain diameter	Maillons Links	Sur rouleau On reel	Rouleau / Reel	
		po. / in.			pi. / ft.	Diam tête Head diam.
627B	BLANC / WHITE	1/4"	1-1/2"	125'	6-1/4"	11"
627J	JAUNE / YELLOW	1/4"	1-1/2"	125'	6-1/4"	11"
627N	NOIR / BLACK	1/4"	1-1/2"	125'	6-1/4"	11"
627FL	FLUORESCENT	1/4"	1-1/2"	125'	6-1/4"	11"

MAILLON D'ACCOUPEMENT EN PLASTIQUE

Quatre (4) maillons par sac poly avec carte de suspension avec code à barres.

PLASTIC CONNECTING LINK

Four (4) links per poly bag with header with bar code.

Numéro produit Product number	Couleur Color	Longueur Length	Quantité / sac Quantity / bag
		po. / in.	
628-4	BLANC / WHITE	1-5/8"	4
628-4J	JAUNE / YELLOW	1-5/8"	4
628-4N	NOIR / BLACK	1-5/8"	4



MAILLON RAPIDE EN PLASTIQUE

Trois (3) maillons par sac poly avec carte de suspension avec code à barres.

PLASTIC RAPID LINK

Three (3) links per poly bag with header with bar code.

Numéro produit Product number	Couleur Color	Longueur Length	Quantité / sac Quantity / bag
		po. / in.	
629-3	BLANC / WHITE	2-5/16"	3
629-3J	JAUNE / YELLOW	2-5/16"	3
629-3N	NOIR / BLACK	2-5/16"	3

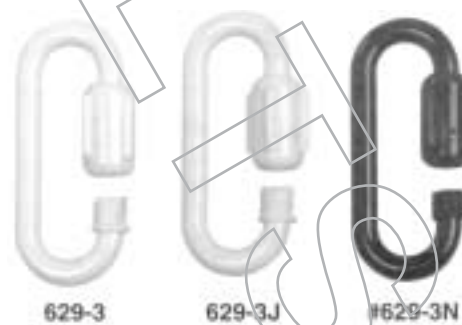

MANILLE DROITE POUR FERME

Acier forgé à haute résistance, cheville d'acier traité thermiquement et plaqué zinc.

Numéro produit Product number	DIAM		S	L	A	F	Effort admissible Safe working load	Emb. Pack
	C	G						
	po. / in.							
M8878	3/4"	7/8"	1-5/16"	3-1/4"	2"	13/16"	16,000	5
M8178	3/4"	7/8"	1-5/16"	4-1/4"	2-3/4"	13/16"	16,000	5

FARM STRAIGHT SHACKLE

Forged of high strength steel, zinc plated, heat treated pin.

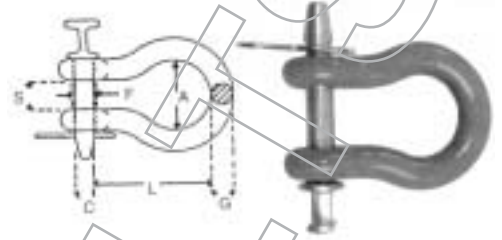

MANILLE TORSADÉE POUR FERME

Acier forgé à haute résistance, cheville d'acier traité thermiquement et plaqué zinc.

Numéro produit Product number	DIAM		S	L	A	Effort admissible Safe working load	Emb. Pack
	Cheville Pin	G					
	po. / in.						
M8078	3/4"	7/8"	1-5/16"	3"	1-3/4"	16,000	5
M9278	3/4"	7/8"	1-5/16"	3-7/8"	2-5/8"	16,000	5

FARM TWIST SHACKLE

Forged of high strength steel, zinc plated, heat treated pin.

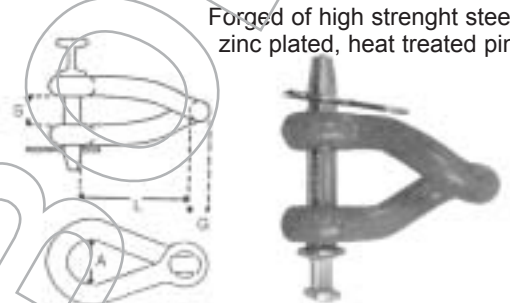

MAILLON DOUBLE À CHAPE

Acier forgé et traité thermiquement, plaqué zinc brillant. Facile à monter ou à enlever. #M605 & M606 sont compatibles avec la chaîne G-70. Aussi employé avec la chaîne éprouvée ordinaire.

En sac poly avec étiquette code à barres.

Numéro produit Product number	Pour chaîne For chain	S	E	P	L	F	G	Effort admissible Safe working load	Emb. Pack
		po. / in.							
		lb							
M605	1/4" - 5/16"	7/16"	5/16"	3/8"	1-9/16"	3/8"	15/16"	4,700	1
M606	3/8"	1/2"	3/8"	15/32"	1-13/16"	7/16"	1"	6,600	1
M608	7/16" - 1/2"	5/8"	1/2"	19/32"	2-5/16"	9/16"	1-5/16"	11,300	1

TWIN CLEVIS MID-LINK

Forged & heat treated, bright zinc plated. Easy to install or remove. #M605 & M606 compatible with G-70 chain. Also used with proof coil chain.

In poly bag with bar code sticker.

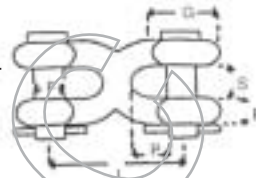

CROCHET DE TRACTEUR

Acier forgé à haute résistance, traité thermiquement. Se fixe à la barre du tracteur jusqu'à 1-5/8" d'épaisseur. Employé avec chaîne de 5/16" à 1/2"

Numéro produit Product number	Pour chaîne For chain	Effort admissible Safe working load	Emb. Pack
M834	1/2"	9,200	5

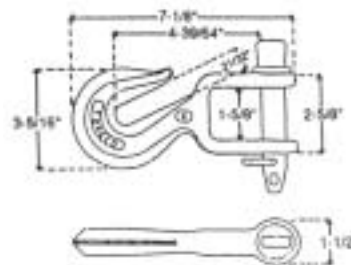

TRACTOR DRAWBAR HOOK

Forged of high strength steel, heat treated. Fits tractor drawbar up to 1-5/8" thick. Use with chain sizes 5/16" to 1/2".

Chaînes et accessoires / Chains and accessories

MANILLE DE CHAÎNE

Avec cheville ronde filetée.
Acier forgé, galvanisé à chaud.
Les chevilles sont galvanisées après le filetage.

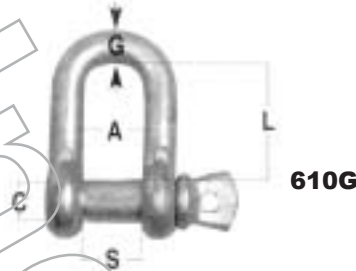

CHAIN SHACKLE

With screw collar pin, drop forged steel,
hot dip galvanized. Collar pins are
galvanized after threading.

Numéro produit Product number	G	C	A	L	S	Effort admissible Safe working load	Poids approx / 100 pièces Approx. weight / 100 pieces	Emb. Pack	G
	Grandeur Size	Diamètre cheville Pin diameter	Largeur interne Inside width at bow	Longueur interne Inside length					Grandeur Size
	po. / in.								tonnes / tons
610G05	3/16"	1/4"	3/8"	3/4"	3/8"	0.08	4	10	3/16"
610G06	1/4"	5/16"	1/2"	15/16"	1/2"	0.15	8	10	1/4"
610G08	5/16"	3/8"	5/8"	1-3/16"	9/16"	0.26	16	10	5/16"
610G10	3/8"	7/16"	7/8"	1-1/2"	3/4"	0.45	30	10	3/8"
610G11	7/16"	1/2"	13/16"	1-3/4"	13/16"	0.55	40	10	7/16"
610G13	1/2"	9/16"	1"	1-13/16"	13/16"	0.75	60	10	1/2"
610G16	5/8"	3/4"	1-1/4"	2-13/16"	1"	1.15	120	1	5/8"
610G19	3/4"	7/8"	1-1/2"	3-3/16"	1-1/4"	1.70	240	1	3/4"
610G22	7/8"	1"	1-1/2"	3-3/8"	1-1/4"	2.30	300	1	7/8"
610G25	1"	1-1/8"	1-13/16"	3-1/2"	1-11/16"	3.00	450	1	1"

MANILLE D'ANCRE

Avec cheville ronde filetée à collier.
Acier forgé, galvanisé à chaud.
Les chevilles sont galvanisées après le filetage.

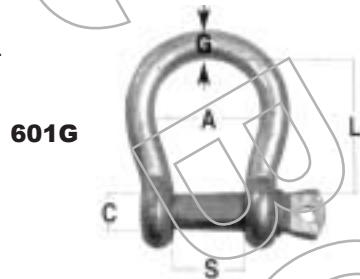

ANCHOR SHACKLE

With screw collar pin, drop forged steel,
hot dip galvanized. Collar pins are
galvanized after threading.

Numéro produit Product number	No. produit avec code à barres Product no with bar code	G	C	A	L	S	Effort admissible Safe working load	Poids approx / 100 pièces Approx. weight / 100 pieces	Emb. Pack	
		Grandeur Size	Diamètre cheville Pin diameter	Largeur interne Inside width at bow	Longueur interne Inside length					Grandeur Size
		po. / in.								tonnes / tons
601G05	601G05BC	3/16"	1/4"	5/8"	3/4"	3/8"	0.08	5	10	
601G06	601G06BC	1/4"	5/16"	17/32"	1-1/8"	1/2"	0.15	8	10	
601G08	601G08BC	5/16"	3/8"	3/4"	1-3/16"	1/2"	0.26	16	10	
601G10	601G10BC	3/8"	7/16"	1-3/16"	1-7/16"	11/16"	0.45	32	10	
601G11	601G11BC	7/16"	1/2"	1-3/8"	1-5/8"	11/16"	0.55	40	10	
601G13	601G13BC	1/2"	9/16"	1-1/2"	1-15/16"	13/16"	0.75	64	10	
601G16	601G16BC	5/8"	11/16"	2"	2-3/4"	1-1/16"	1.15	130	1	
601G19	601G19BC	3/4"	7/8"	2-1/8"	2-7/8"	1-5/32"	1.70	240	1	
601G22	---	7/8"	1"	2-5/8"	3-1/2"	1-1/2"	2.30	340	1	
601G25	---	1"	1-1/8"	2-7/8"	3-11/16"	1-1/2"	3.00	450	1	

MANILLE D'ANCRE AVEC CHEVILLE RONDE FILETEE

Forgé à chaud, alliage d'acier, galvanisé à chaud.
 Fabriqué selon les normes fédérales RR-C-271a.
 Type IV Classe 1. Charge sécuritaire et grandeur sont gravées en relief sur le maillon.
 Fabrication : acier C-1045, AISI 4130é
 tige en alliage d'acier.

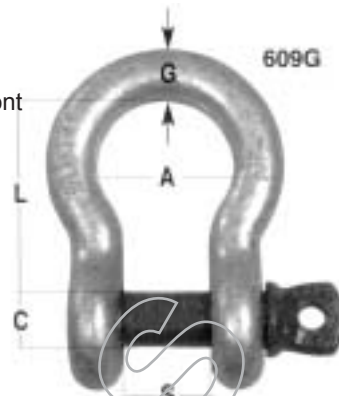

SCREW PIN ANCHOR SHACKLE LOAD RATED

Drop forged , alloy steel, hot dip galvanized.
 As per federal specifications RR-C-271a.
 Type IV Class 1. Load limit and size embossed on body of shackle.
 Material : C-1045 steel body,
 AISI 4130, alloy steel pin.

Numéro produit Product number	G	C	A	L	S	Effort admissible Safe working load	Poids approx / 100 pièces Approx. weight / 100 pieces	Emb. Pack	G
	Grandeur Size	Diamètre cheville Pin diameter	Largeur interne Inside width at bow	Longueur interne Inside length					Grandeur Size
	po. / in.								tonnes / tons
609G06	1/4"	5/16"	25/32"	1-1/8"	7/16"	1/2	12	10	1/4"
609G08	5/16"	3/8"	27/32"	1-7/32"	9/16"	3/4	19	10	5/16"
609G10	3/8"	7/16"	1-1/32"	1-7/16"	5/8"	1	31	10	3/8"
609G11	7/16"	1/2"	1-5/32"	1-11/16"	11/16"	1-1/2	38	10	7/16"
609G13	1/2"	5/8"	1-5/16"	1-7/8"	13/16"	2	75	10	1/2"
609G16	5/8"	3/4"	1-11/16"	2-3/8"	1-1/16"	3-1/4	143	1	5/8"
609G19	3/4"	7/8"	2"	2-3/4"	1-1/4"	4-3/4	220	1	3/4"
609G22	7/8"	1"	2-9/32"	3-1/4"	1-3/8"	6-1/2	352	1	7/8"
609G25	1"	1-1/8"	2-11/16"	3-5/8"	1-3/4"	8-1/2	528	1	1"
609G29	1-1/8"	1-1/4"	2-7/8"	4-1/4"	1-3/4"	9-1/2	704	1	1-1/8"
609G32	1-1/4"	1-3/8"	3-1/4"	4-11/16"	2"	12	968	1	1-1/4"
609G38	1-1/2"	1-9/16"	3-7/8"	5-3/4"	2-3/8"	17	1,760	1	1-1/2"

MAILLON RAPIDE

Pour chaînes et autres assemblages, charge de sûreté éprouvée, filets à chaque extrémité guidant la noix et facilitant le travail. Aucun outil requis même sous tension.
 Fabriqué en France.

QUICK LINK

For chains and other connections, tested for safe working loads, threads on both ends give firm guidance to the nut assuring easy operation without any tool even under tension. Made in France.

Numéro produit Product number	Grandeur Size	Longueur interne Inside length	Effort admissible Safe working load	Boîte Box
	po. / in.			
	lb			
1333-03	1/8"	1-1/4"	220	20
1333-05	3/16"	1-1/2"	620	20
1333-06	1/4"	1-3/4"	890	20
1333-08	5/16"	2-1/4"	1,550	20
1333-10	3/8"	2-1/2"	2,000	10
1333-11	7/16"	2-3/4"	2,440	10
1333-13	1/2"	3-1/8"	3,330	10
1333-14	9/16"	3-5/8"	4,880	10
1333-16	5/8"	4-1/4"	6,440	10
1333-17	11/16"	4-3/4"	7,770	10



1333

Chaînes et accessoires / Chains and accessories

MAILLON RAPIDE

Maillon en acier plaqué zinc. Pour assemblage d'accessoires à la chaîne. Aucun outil requis. Filets à chaque extrémité pour guider l'écrou.

RAPID LINK

Zinc plated steel link. For assembling chain accessories. No tool required. Threads at both ends for guiding the nut.

PLAQUÉ ZINC

ZINC PLATED

Numéro produit Product number	No. produit avec code à barres Product no with bar code	D		A		L		O	Emb. Pack
		Diamètre Diameter		Largeur interne Inside width		Longueur interne Inside length		Ouverture Opening	
		po. / in.		mm					
2333-03	2333-03BC	1/8"	3	11	31	4.5	20		
2333-04	2333-04BC	5/32"	4	12	34	5.0	20		
2333-05	2333-05BC	3/16"	5	13	39	6.5	20		
2333-06	2333-06BC	1/4"	6	14	45	7.5	20		
2333-08	2333-08BC	5/16"	8	17	58	10.0	20		
2333-10	2333-10BC	3/8"	9	21	70	11.5	10		
2333-11	2333-11BC	7/16"	11	22	78	13.5	10		
2333-13	2333-13BC	1/2"	13	24	80	13.5	10		



MAILLON RAPIDE

Maillon en acier plaqué zinc. Pour assemblage d'accessoires à la chaîne. Aucun outil requis. Filets à chaque extrémité pour guider l'écrou. Sur carte avec code à barres

RAPID LINK

Zinc plated steel link. For assembling chain accessories. No tool required. Threads at both ends for guiding the nut. Carded with bar code.

PLAQUÉ ZINC

ZINC PLATED

Numéro produit Product number	Diamètre / Diameter	Quantité / carte Quantity / card	Cartes / boîte Cards / box
	po. / in.		
2333C03	1/8"	2	10
2333C04	5/32"	2	10
2333C05	3/16"	2	10
2333C06	1/4"	2	10
2333C08	5/16"	1	10
2333C10	3/8"	1	10

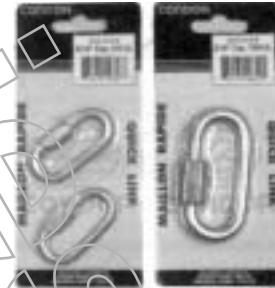

MAILLON À RIVET

Forgé à chaud. Pour servir comme attache de chaîne temporaire ou permanente. Le maillon est pourvu de pattes enclenchées et de rivets. Pour les installations permanentes, les rivets doivent être aboutés dans les fraises. Pour être employé avec la chaîne de qualité 30 ou de résistance inférieure. Selon les spécifications RR-C-271B, Type 2, du bureau fédéral américain.

MISSING LINK

Drop forged For connection of attachment to chain. Link is provided with interlocking lugs and rivets. For permanent connections, the rivets must be peened into the counter sunk holes. To be used with grade 30 or lower grade chain. As per United States Federal specifications RR-C-271B, Type 2.

Numéro produit Product number	No. produit avec code à barres Product no with bar code	D		A		L		Poids approx. / 100 pièces Approx. weight / 100 pieces	Emb. Pack
		Diamètre Diameter		Largeur interne Inside width		Longueur interne Inside length			
		po. / in.							
701-05	701-05BC	3/16"	11/32"	11/16"	4	10			
701-06	701-06BC	1/4"	7/16"	7/8"	6	10			
701-08	701-08BC	5/16"	15/32"	15/16"	10	10			
701-10	701-10BC	3/8"	9/16"	1-1/8"	18	10			
701-13	701-13BC	1/2"	21/32"	1-15/32"	37	10			
701-16	---	5/8"	25/32"	1-13/16"	70	5			
701-19	---	3/4"	15/16"	2-1/8"	119	5			
701-22	---	7/8"	1-1/8"	2-1/2"	182	5			

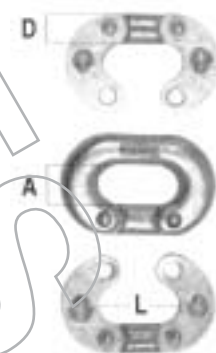

ÉMÉRILLON

CHAIN SWIVEL

EN FONTE MALLÉABLE PLAQUÉ ZINC

ZINC PLATED MALLEABLE IRON

Numéro produit Product number	No produit avec code barres Product no with bar code	Diamètre tige Shank diameter	Diamètre oeil Eye diameter	Longueur Length	Boîte Box
466-05	466-05BC	3/16"	1/4"	1-13/16"	20
466-06	466-06BC	1/4"	3/8"	2-3/8"	20
466-08	466-08BC	5/16"	1/2"	2-3/4"	10
466-10	466-10BC	3/8"	7/16"	3-1/4"	10



MAILLON FROID

COLD SHUT

EN ACIER PLAQUÉ ZINC

ZINC PLATED STEEL

Numéro produit Product number	No produit avec code barres Product no with bar code	Diamètre tige Shank diameter	Longueur interne Inside length	Largeur interne Inside width	Boîte Box
631-05	631-05BC	3/16"	15/16"	5/16"	20
631-06	631-06BC	1/4"	1"	3/8"	20
631-08	631-08BC	5/16"	1-3/16"	7/16"	20
631-10	631-10BC	3/8"	1-5/16"	1/2"	20
631-11	631-11BC	7/16"	1-1/2"	9/16"	10
631-13	631-13BC	1/2"	1-9/16"	3/4"	10



MAILLON FENDU

SPLIT REPAIR (LAP) LINK

EN ACIER PLAQUÉ ZINC

ZINC PLATED STEEL

Numéro produit Product number	No produit avec code barres Product no with bar code	Diamètre tige Shank diameter	Longueur interne Inside length	Boîte Box
635-03	635-03BC	1/8"	3/4"	20
635-05	635-05BC	3/16"	1"	20
635-06	635-06BC	1/4"	1-1/4"	20
635-08	635-08BC	5/16"	1-1/2"	20
635-10	635-10BC	3/8"	1-5/8"	20
635-13	635-13BC	1/2"	2-1/2"	10



Chaînes et accessoires / Chains and accessories

CROCHETS FORGÉS À CHAÎNE

QUALITÉ 30 FINI NATUREL

Avec étiquette code à barres.

645
Crochet fermé à œillet
Eye grab hook



646
Crochet ouvert à œillet
Eye slip hook



647
Crochet fermé à chape
Clevis grab hook



648
Crochet ouvert à chape
Clevis slip hook



FORGED CHAIN HOOKS

GRADE 30 SELF-COLOURED FINISH

With bar code sticker.

Numéro produit Product number	Grandeur Size	Poids / 100 Weight / 100
	po. / in.	lb
645-06	1/4"	32
645-08	5/16"	52
645-10	3/8"	86
645-11	7/16"	115
645-13	1/2"	200
645-16	5/8"	325
645-19	3/4"	594

Numéro produit Product number	Grandeur Size	Poids / 100 Weight / 100
	po. / in.	lb
646-06	1/4"	29
646-08	5/16"	43
646-10	3/8"	83
646-11	7/16"	124
646-13	1/2"	205
646-16	5/8"	378
646-19	3/4"	656

Numéro produit Product number	Grandeur Size	Poids / 100 Weight / 100
	po. / in.	lb
647-06	1/4"	34
647-08	5/16"	64
647-10	3/8"	102
647-11	7/16"	150
647-13	1/2"	216
647-16	5/8"	425
647-19	3/4"	650

Numéro produit Product number	Grandeur Size	Poids / 100 Weight / 100
	po. / in.	lb
648-06	1/4"	36
648-08	5/16"	56
648-10	3/8"	93
648-11	7/16"	190
648-13	1/2"	232
648-16	5/8"	475
648-19	3/4"	1,128

CROCHETS À OEIL

Acier au carbone

Crochet à oeil avec linguet de sécurité. Avec étiquette code à barres.

Eye hook with latch. With bar code sticker.



Numéro produit Product number	D	A	Effort admissible Safe working load
	po. / in.		
320CWL-0075	3/4"	13/16"	3/4
320CWL-010	7/8"	15/16"	1
320CWL-015	1-1/16"	15/16"	1-1/2
320CWL-020	1-1/4"	1"	2
320CWL-030	1-1/2"	1-1/4"	3
320CWL-050	2"	1-1/4"	5
320CWL-075	2-7/16"	2-1/4"	7-1/2
320CWL-100	2-13/16"	2-1/2"	10
320CWL-150	3-1/2"	3-3/8"	15

EYE HOOKS

Carbon steel.

Crochet à oeil tournant avec linguet de sécurité. Avec étiquette code à barres.

Swivel eye hook with latch. With bar code sticker.



Numéro produit Product number	Effort admissible Safe working load
	tonnes / tons
322CWL-0075	3/4
322CWL-010	1
322CWL-015	1-1/2
322CWL-020	2
322CWL-030	3
322CWL-050	5

Dispositif de sécurité en acier inoxydable.



Stainless steel latch kit.

Numéro produit Product number	Pour crochet For hook
	tonnes / tons
S4055-0075	3/4
S4055-010	1
S4055-015	1-1/2
S4055-020	2
S4055-030	3
S4055-050	5
S4055-075	7-1/2
S4055-100	10
S4055-150	15

MOUFLES EN ACIER

Avec crochet ouvert.

STANDARD STEEL TACKLE BLOCK

With loose side hook.

SIMPLE / SINGLE

H261C

Numéro produit Product number	Grosueur Size	Diamètre câble Rope diameter
	po. / in.	
H261C3	3"	3/8"
H261C4	4"	1/2"
H261C5	5"	5/8"
H261C6	6"	3/4"



H261C

DOUBLE

H262C

Numéro produit Product number	Grosueur Size	Diamètre câble Rope diameter
	po. / in.	
H262C3	3"	3/8"
H262C4	4"	1/2"
H262C5	5"	5/8"
H262C6	6"	3/4"

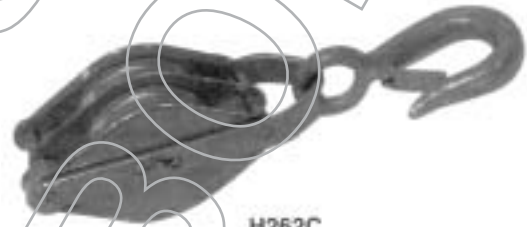

H262C

TRIPLE

H263C

Numéro produit Product number	Grosueur Size	Diamètre câble Rope diameter
	po. / in.	
H263C3	3"	3/8"
H263C4	4"	1/2"
H263C5	5"	5/8"
H263C6	6"	3/4"

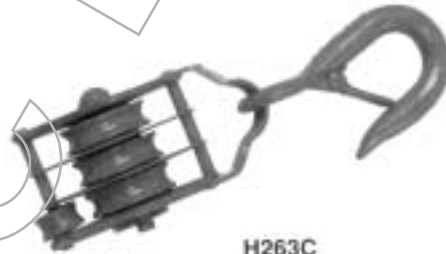

H263C

MOUFLES À CROCHET

SNATCH BLOCK

Numéro produit Product number	Diamètre câble Rope diameter	Effort admissible Safe working load	Diamètre extérieur réa. Sheave outside diameter	Poids unitaire Weight
	po. / in.	tonnes / tons	po. / in.	lb
10611	1/2"	2	6"	14
10811	5/8"	3	8"	24



Chaînes et accessoires / Chains and accessories

ATTACHE DE CHARGE

Modèle robuste, acier forgé, pivotant.
Avec étiquette code à barres.

Modèle spécial robuste complet avec deux pivots. Acier forgé à la chaleur pour un maximum de force et de durabilité.
Cheville robuste à l'arrière de l'ouverture dans le manche qui prévient l'écartement.
Crochets courts robustes en acier forgé avec oeil ovale large et maillons soudés à l'électricité.



LOAD BINDER

Heavy duty, drop forged, swivel pattern. With bar code sticker.
A special heavy duty model complete with two swivels. Hot drop forged steel, heat treated throughout for maximum strength and durability.
Non spread design with clevis pins at rear of slot in handle. Special heavy duty forged steel stub hooks with large oval eye and electroweld links.

Numéro produit Product number	Capacité chaîne Chain capacity	Ouverture Open spread	Raccourcissement Take up	Longueur levier Take up	Poids Weight	Effort admissible Safe working load	Résistance nominale à la rupture Nominal breaking strength	Emb. Pack
BX271	1/4"	15-1/2"	3-1/2"	13"	3.5	1,250	1,250	10
BX320	5/16" - 3/8"	22-1/2"	4-1/2"	16"	8.0	5,400	5,400	5
BX340	3/8" - 1/2"	28-1/2"	5-1/8"	18-1/2"	14.0	9,200	9,200	1

ATTACHE DE CHARGE À CLIQUET

Facile à manipuler, ajustement progressif, pièces de support en acier forgé.
Avec étiquette code à barres.



RATCHET LOAD BINDER

Easy turning precision threads, rugged ratchet and pawl positive locking action easy release, forged eye bolts.
With bar code sticker.

Numéro produit Product number	Capacité chaîne Chain capacity	Raccourcissement Take up	Longueur levier Take up	Poids Weight	Effort admissible Safe working load	Résistance nominale à la rupture Nominal breaking strength	Emb. Pack
BXR320	5/16" - 3/8"	8"	15-3/4"	9,5	6,600	19,000	5

ATTACHE DE CHARGE

Modèle léger.
Avec étiquette code à barres.

Modèle mini léger conçu pour utilisation avec remorques de bateau et toutes sortes de véhicules récréatifs. Un crochet pivote sur 360°. Pour être employé avec la chaîne de qualité 30 ou de résistance inférieure.

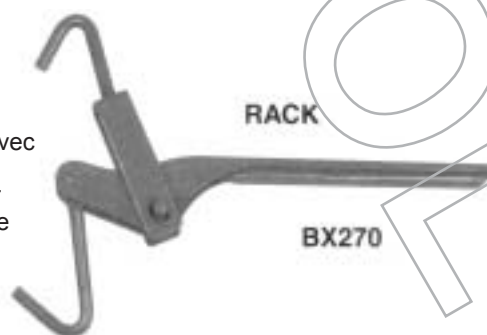

LOAD BINDER

Light weight model. With bar code sticker
Light weight mini-binder designed for use on boat trailers and recreational vehicles of all kinds. One hook swivel 360°. To be used with grade 30 or lower grade chain.

Numéro produit Product number	Capacité chaîne Chain capacity	Ouverture Open spread	Raccourcissement Take up	Longueur levier Take up	Poids Weight	Effort admissible Safe working load	Résistance nominale à la rupture Nominal breaking strength	Emb. Pack
BX270	3/16"	12"	2-3/4"	7-1/2"	1,25	750	1,250	10

MOUSQUETON DE SÉCURITÉ BRONZE

Verrouillage à bille maintenant la bague en bronze ouverte ou fermée, qui permet de libérer l'animal en cas d'incendie ou d'urgence, et l'empêche de s'étrangler en cas de chute.



SECURITY SNAP HOOK BRONZE

Positive ball lock holds bronze ring in opened or closed position. Allows animals to be freed immediately in case of fire or another emergency. Avoids animal choking if they fall.

Numéro produit Product number	No produit avec code barres Product no. with bar code	Diamètre oeil Eye diameter	Longueur Length	Résistance nominale à la rupture Nominal breaking strength	Emb. Pack
		po. / in.		lb	
3002	3002BC	1"	4-1/2"	2,000	5

MOUSQUETON DE SÉCURITÉ ZINC BRILLANT

Verrouillage à bille maintenant la bague en bronze ouverte ou fermée, qui permet de libérer l'animal en cas d'incendie ou d'urgence, et l'empêche de s'étrangler en cas de chute. Fabriqué en France.

Peu importe la charge, le dispositif de sécurité permet à la bague de tourner et de s'ouvrir pour libérer l'animal.

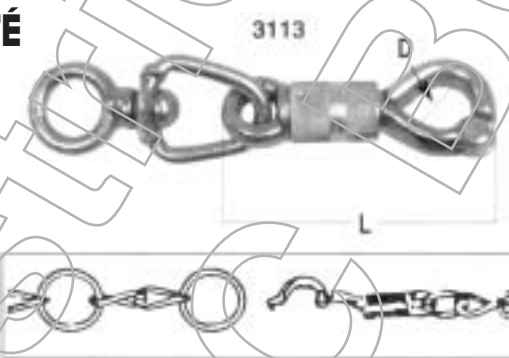

SECURITY SNAP HOOK BRIGHT ZINC

Positive ball lock holds bronze ring in opened or closed position. Allows animals to be freed immediately in case of fire or another emergency. Avoids animal choking if they fall. Made in France.

With the security, whatever the load, simply rotate the ring to free the animal.

Numéro produit Product number	Diamètre oeil Eye diameter	Longueur Length	Poids avec émerillon / 100 Weight with swivel / 100	Résistance nominale à la rupture Nominal breaking strength	Emb. Pack
	mm			kg	
3113-85	17	85	18,2	1,300	5
3113-100	20	100	29,0	1,500	5

ÉMERILLON EN ACIER ZINC BRILLANT

Fabriqué en France.

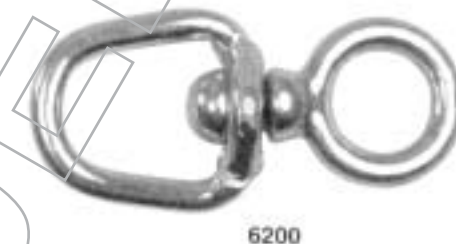

STEEL SWIVEL BRIGHT ZINC

Made in France.

Numéro produit Product number	Grandeur Size		Diamètre oeil Eye diameter	Poids / 100 Weight / 100	Résistance nominale à la rupture Nominal breaking strength	Emb. Pack
	po. / in.	mm	po. / in.	lb	tonnes / tons	
6260	1/4"	6	5/8"	12	1.0	10
6270	9/32"	7	3/4"	19	1.5	10
6280	5/16"	8	7/8"	30	2.0	10

POULIE SIMPLE À AUVENT OEIL FIXE

En fonte, galvanisée. Avec étiquette code à barres

Numéro produit Product number	D		Emb. Pack
	Diamètre extérieur réa. Sheave outside diameter		
	po. / in		
653-05	1/2"		24
653-075	3/4"		24
653-10	1"		24
653-125	1-1/4"		12
653-15	1-1/2"		12
653-20	2"		12
653-25	2-1/2"		6
653-30	3"		6

SINGLE AWNING PULLEY FIXED EYE

Cast iron, galvanized. With bar code sticker.



POULIE DOUBLE À AUVENT OEIL FIXE

En fonte, galvanisée. Avec étiquette code à barres

Numéro produit Product number	D		Emb. Pack
	Diamètre extérieur réa. Sheave outside diameter		
	po. / in		
654-05	1/2"		24
654-075	3/4"		24
654-10	1"		24
654-125	1-1/4"		12
654-15	1-1/2"		12
654-20	2"		12
654-25	2-1/2"		6
654-30	3"		6

DOUBLE AWNING PULLEY FIXED EYE

Cast iron, galvanized. With bar code sticker.

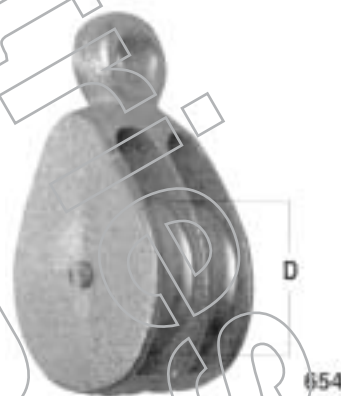

POULIE SIMPLE À AUVENT OEIL PIVOTANT

En fonte, galvanisée. Avec étiquette code à barres







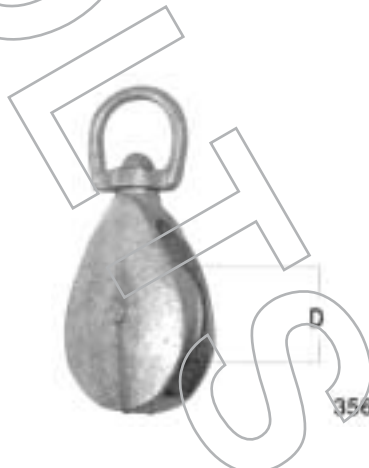







Numéro produit Product number	D		Emb. Pack
	Diamètre extérieur réa. Sheave outside diameter		
	po. / in		
356-05	1/2"		24
356-075	3/4"		24
356-10	1"		24
356-125	1-1/4"		12
356-15	1-1/2"		12
356-20	2"		12

SINGLE AWNING PULLEY SWIVEL EYE









Cast iron, galvanized. With bar code sticker.















Chaînes et accessoires / Chains and accessories

Numéro produit Product number	No. Produit avec code à barres Product No with bar code	MOUSQUETONS SNAP HOOKS		Diamètre oeil Eye diameter	Longueur Length	Emb. Pack
				po. / in		
734A	734ABC	Mousqueton simplex, oeil pivotant Simplex wire snap, swivel eye		1/2"	1-1/2"	10
150	150BC	Mousqueton oeil fixe Baby snap, fixed eye		3/8"	1-3/4"	10
108-19	108-19BC	Mousqueton oeil rond Champion snap, round eye		3/4"	3-3/8"	10
1087	734ABC	Mousqueton oeil pivotant ouvert Champion snap, swivel round eye		3/8"	2-1/2"	10
1088	734ABC	Mousqueton oeil carré à rouleau Eye snap, square eye with roller		3/8"	2-1/2"	10
1089	734ABC	Mousqueton simplex, oeil pivotant Simplex wire snap, swivel eye		5/8"	2-1/4"	10
50-10 50-13 50-16 50-19 50-25 50-28	50-10BC 50-13BC 50-16BC 50-19BC 50-25BC 50-28BC	Mousqueton à boulon, oeil pivotant Bolt snap, Swivel eye		3/8" 1/2" 5/8" 3/4" 1" 1-1/8"	3" 3" 3-1/4" 3-3/8" 3-7/8" 4-1/4"	10 10 10 10 10 10
70	70BC	Mousqueton à boulon, oeil ouvert Bolt snap, open eye		5/8"	4"	10
52-19 52-25	52-19BC 52-25BC	Mousqueton à boulon, oeil carré pivotant Bolt snap, square swivel eye		3/4" 1"	3" 3"	10 10
72-35 72-4 72-45	72-35BC 72-4BC 72-45BC	Mousqueton à boulon double Double bolt snap		1/2" 1/2" 1/2"	3-1/2" 4" 4-1/2"	10 10 10
135-19 135-25 135-29 135-38 135-51	135-19BC 135-25BC 135-29BC 135-38BC 135-51BC	Mousqueton oeil carré fixe, acier malléable Champion snap, square-fixed eye malleable cast steel		3/4" 1" 1-1/8" 1-1/2" 2"	2-5/8" 3-1/8" 3-1/8" 3-1/8" 3-1/2"	10 10 10 5 5
188-16 188-19 188-25 188-29	188-16 188-19 188-25 188-29	Mousqueton oeil pivotant, ressort inoxydables Lever snap, swivel eye, stainless springs		5/8" 3/4" 1" 1-1/8"	3-1/8" 3-1/4" 3-1/2" 4-3/4"	10 10 10 10
187	187BC	Mousqueton oeil double Snap, double breast		---	5"	5
4218	4218BC	Mousqueton type ciseau, oeil pivotant Scissor snap, swivel eye		5/8"	3"	10





Chaînes et accessoires / Chains and accessories



Numero produit Product number	No. Produit avec code à barres Product No with bar code	MOUSQUETONS SNAP HOOKS	Diamètre oeil Eye diameter	Longueur Length	Emb. Pack	
			po. / in			
3142 3145	3142BC 3145BC	Mousqueton sécuritaire, oeil pivotant Security snap hook, swivel eye		7/8" 1"	3-3/4" 5"	10 5
1001	1001BC	Mousqueton anti-panique, oeil fixe Panic snap, fixed eye		1/2"	4"	5
1002	1002BC	Mousqueton anti-panique, oeil pivotant Panic snap, swivel eye		7/8"	4-3/4"	5
2311	2311BC	Mousqueton d'amarrage Mooring snap		3/4"	3-1/2"	5
2355/50 2355/60 2355/80 2355/100 2355/120 2355/140	2355/50BC 2355/60BC 2355/80BC 2355/100BC 2355/120BC 2355/140BC	Mousqueton de sécurité en fil de fer, plaqué zinc Security wire snap hook, zinc plated		3/16" 1/4" 5/16" 3/8" 7/16" 15/32"	2" 2-1/4" 3-1/8" 4" 4-3/4" 5-1/2"	10 10 10 10 10 10
Numéro produit Product number	No. Produit avec code à barres Product No with bar code	MOUSQUETONS EN LAITON POUR BATEAU POLISH BRASS BOAT SNAPS	Diamètre oeil Eye diameter	Longueur Length	Emb. Pack	
			po. / in			
2359-13 2359-19 2359-25	2359-13BC 2359-19BC 2359-25BC	Mousqueton à boulon en laiton, oeil pivotant Brass boat snap, swivel eye		1/2" 3/4" 1"	3-1/8" 3-1/4" 3-1/2"	10 10 10
2363/0 2363/1 2363/2 2363/3	2363/0BC 2363/1BC 2363/2BC 2363/3BC	Mousqueton pour bateaux en laiton, oeil fixe Brass boat snap, fixed eye		7/16" 5/8" 3/4" 3/4"	2-1/8" 2-7/8" 3-1/4" 3-7/8"	10 10 10 10
2364/1 2364/2 2364/3	2364/1BC 2364/2BC 2364/3BC	Mousqueton pour bateaux en laiton, oeil pivotant Brass boat snap, swivel eye		5/8" 3/4" 3/4"	3-1/4" 3-3/4" 4-1/4"	10 10 10
163B	163BBC	Mousqueton à boulon double en laiton Brass bolt snap double eye		1/2"	4-1/2"	10
232B	232BBC	Mousqueton en laiton, oeil ouvert Brass bolt snap open eye		1/2"	4"	10
Numéro produit Product number	No. Produit avec code à barres Product No with bar code	ANNEAUX RONDS ROUND RINGS	Diamètre oeil Eye diameter	Longueur Length	Emb. Pack	
			po. / in			
1336-075 1336-1 1336-125 1336-15 1336-175 1336-2	1336-075BC 1336-1BC 1336-125BC 1336-15BC 1336-175BC 1336-2BC	Anneau soudé en acier, plaqué nickel Nickel plated welded steel ring		3/4" 1" 1-1/4" 1-1/2" 1-3/4" 2"	11/64" 3/16" 3/16" 1/4" 1/4" 1/4"	20 20 20 20 20 20
1347-15 1347-2 1347-25 1347-3	1347-15BC 1347-2BC 1347-25BC 1347-3BC	Anneau soudé en acier au carbone, galvanisé à chaud Hot dip galvanized welded carbon steel ring		1-1/2" 2" 2-1/2" 3"	1/4" 1/4" 5/16" 3/8"	20 20 20 10

Chaînes et accessoires / Chains and accessories

Numéro produit Product number	MOUSQUETONS SUR CARTE CARDED SNAP HOOKS 	Diamètre oeil Eye diameter	Longueur Length	Quantité / carte Quantity / card	Cartes / boîte Cards / box
		po. / in			
50C10 50C13 50C16 50C19 50C25 50C28	Mousqueton à boulon, oeil pivotant Bolt snap, swivel eye 	3/8"	3"	1	10
		1/2"	3"	1	10
		5/8"	3-1/4"	1	10
		3/4"	3-3/8"	1	10
		1"	3-7/8"	1	10
		1-1/8"	4-1/4"	1	10
70C	Mousqueton à boulon, oeil ouvert Bolt snap, open eye 	5/8"	4"	1	10
52C19 52C25	Mousqueton à boulon, oeil carré pivotant Bolt snap, square swivel eye 	3/4"	3"	1	10
		1"	3"	1	10
72C35 72C4 72C45	Mousqueton à boulon double Double bolt snap 	1/2"	3-1/2"	1	10
		1/2"	4"	1	10
		1/2"	4-1/2"	1	10
135C19 135C25	Mousqueton oeil carré fixe, acier malléable Champion snap square fixed eye, Malleable cast steel 	3/4"	2-5/8"	1	10
		1"	3-1/8"	1	10
188C16 188C19 188C25 188C29	Mousqueton oeil pivotant, Ressorts inoxydables Lever snap swivel eye, stainless springs 	5/8"	3-1/8"	1	10
		3/4"	3-1/4"	1	10
		1"	3-1/2"	1	10
		1-1/8"	4-3/4"	1	10
4218C	Mousqueton type ciseau, oeil pivotant Scissor snap, swivel eye 	5/8"	3"	1	10
1001C	Mousqueton anti-panique, oeil fixe Panic snap, fixed eye 	1/2"	4"	1	10
1002C	Mousqueton anti-panique, oeil pivotant Panic snap, swivel eye 	7/8"	4-3/4"	1	10
2311C	Mousqueton d'amarrage 	3/4"	3-1/2"	1	10
2355C50 2355C60 2355C80 2355C100	Mousqueton de sécurité en fil de fer, plaqué zinc Security wire snap hook, zinc plated 	3/16"	2"	1	10
		1/4"	2-1/4"	1	10
		5/16"	3-1/8"	1	10
		3/8"	4"	1	10

Chaînes et accessoires / Chains and accessories

Numéro produit Product number	MOUSQUETONS EN LAITON SUR CARTE CARDED BRASS SNAP HOOKS 	Diamètre oeil Eye diameter	Longueur Length	Quantité / carte Quantity / card	Cartes / boîte Cards / box
		po. / in			
2359C13 2359C19 2359C25	Mousqueton à boulon, oeil pivotant Bolt snap, swivel eye 	1/2"	3-1/8"	1	10
		3/4"	3-1/4"	1	10
		1"	3-1/2"	1	10
2363C0 2363C1 2363C2 2363C3	Mousqueton pour bateaux, oeil fixe Boat snap, fixed eye 	7/16"	2-1/8"	1	10
		5/8"	2-7/8"	1	10
		3/4"	3-1/4"	1	10
		3/4"	3-7/8"	1	10
2364C1 2364C2 2364C3	Mousqueton pour bateaux, oeil pivotant Boat snap, swivel eye 	5/8"	3-1/4"	1	10
		3/4"	3-3/4"	1	10
		3/4"	4-1/4"	1	10

Numéro produit Product number	ANNEAUX RONDS SUR CARTE CARDED ROUNDED RINGS 	Diamètre oeil Eye diameter	Longueur Length	Quantité / carte Quantity / card	Quantité / boîte Quantity / box
		po. / in			
1336C1 1336C125 1336C15 1336C2	Anneau rond en acier, soudé, plaqué nickel Nickel plated round, welded, steel ring 	1/2"	3-1/8"	1	10
		3/4"	3-1/4"	1	10
		1"	3-1/2"	1	10